

MINUTES OF THE MEETING  
OF THE  
MICHIGAN STATE UNIVERSITY  
BOARD OF TRUSTEES

June 17, 2015

President Simon called the meeting of the Board of Trustees to order at 11:15 a.m. in the Board Room.

Trustees present: Brian Breslin, Dianne Byrum, Joel Ferguson, Melanie Foster, Mitch Lyons, Brian Mosallam, George Perles (via telephone), and Diann Woodard.

University officers present: President Simon, Provost and Executive Vice President Youatt, Executive Vice President Udpa, Vice President and Secretary Beekman, Vice President and General Counsel Noto, Vice Presidents Burnham, Gore, Groves, Haas, Hsu, Maybank, Swain, and Young, and Senior Advisor and Director Granberry Russell. Faculty liaisons present: William Davidson II, Phylis Floyd, Mariam Sticklen, and Mary Noel. Student liaisons present: Domonique Clemons and Sudha Sankar.

All actions taken were by unanimous vote of the Trustees present, unless otherwise noted.

1. On a motion by Trustee Foster, supported by Trustee Ferguson, the **BOARD VOTED to approve** the agenda.
2. On a motion by Trustee Ferguson, supported by Trustee Foster, the **BOARD VOTED to approve** the minutes of the April 17, 2015 Board of Trustees meeting.
3. President's Report

President Simon provided the following report to the Board.

A. Student Achievements

The Society of Professional Journalists honored The State News, MSU's student newspaper, as the nation's best daily college newspaper of 2014. This is the first time The State News has won the honor.

MSU computer science senior Angela Sun was one of three women recently honored by the National Center for Women and

Information Technology and was an inaugural winner of the center's Collegiate Award for her innovative mobile app, You++.

The Hoplite Quartet, four trombone students from the MSU College of Music, will travel to Spain in July to compete as the only U.S. group in the finals of the 2015 International Trombone Festival.

#### B. Faculty Achievements

University Distinguished Professor Jack Liu has been elected to the American Philosophical Society, the oldest "learned society" in the United States.

University Distinguished Professor Sheng-Yang He has been elected to the National Academy of Sciences as part of its 2015 class.

College of Veterinary Medicine associate professor Bo Norby was selected as a key stakeholder in the White House's effort to combat antibiotic resistance nationwide.

With her most recent discovery, Professor Pamela Rasmussen, an integrative biologist, is tied for the third-highest number of bird discoveries in the world with 10 – and is ranked first for birds discovered in Asia.

The International Association for Great Lakes Research (IAGLR) has recognized journalism professor David Poulson with the John R. Vallentyne award for career-long dedication to informing and educating the public and policymakers on Great Lakes issues.

#### C. Staff Achievements

MSU College of Engineering academic adviser Dan King has won the 2015 National Academic Advising Association Commission and Interest Group Division Service Award.

MSU's Office of Communications and Brand Strategy captured five award wins out of its seven entries at the 36th Annual Telly Awards, which honor the best in film and video production, web content, local and regional commercials, and long form programs. Over 12,000 entries were submitted.

Its work was also nominated for seven Emmy Awards this year, and this past weekend MSU's Anthony Siciliano was named Best Editor.

Mike Brand, Executive Director of Wharton Center for Performing Arts, was honored at the Broadway League Conference in New York City with the Samuel J. L'Hommedieu Award, the highest award that can be given to an executive of a performing arts center affiliated with Broadway touring companies.

#### D. University-wide Rankings and Awards

MSU's Broad College of Business MBA program is on U.S. News and World Report's list of top 10 MBA Programs With The Most Employed Graduates, with 95.6 percent of full-time MBA graduates having landed a job within three months after graduating in 2014.

Business Insider recently released a list of the 50 U.S. colleges with the best food, placing MSU at No. 20 and as the top university in Michigan.

Chittenden Hall was chosen as the recipient of the Michigan Historic Preservation Network 2015 Building Award, recognizing an outstanding building preservation completed within the last three years.

#### E. Athletics

The spring season was a strong one in the classroom for MSU student-athletes, with 108 individuals recognized with Academic All-Big Ten honors.

Last month, the MSU women's track and field team won its second Big Ten outdoor track and field title in program history, behind senior Leah O'Connor's wins in the 1,500 and 5,000-meter races.

Michigan State Director of Intercollegiate Athletics Mark Hollis was recently inducted into the National Association of Collegiate Marketing Administrators Hall of Fame in Orlando. Hollis was one of two inductees honored at the Association's annual convention earlier this week.

Michigan State basketball great Steve Smith has been named one of this year's three winners of the Basketball Hall of Fame's

humanitarian award, the Mannie Jackson Award, for his charitable work, donations, and dedication to making the world a better place. The award will be presented September 10 at the Hall in Springfield, Massachusetts.

4. Public Participation on Issues Germane to the Agenda.

A. State Police Post Redevelopment

Ruth Ann Stump, President of the Red Cedar Community Association, said that the neighborhood is one of the oldest in East Lansing with residents who include current and former MSU faculty, staff, and students. Ms. Stump voiced concern with the plans for the four-story apartment buildings that would be placed very close to the current residences. Ms. Stump asked MSU to move or reduce the height of the buildings. Additionally, Ms. Stump asked that the traffic flow on Harrison Road be examined more closely, especially egress from the proposed parking ramp.

Susan Chalgian, MSU staff member, said that she was representing the Trowbridge Business Association. Ms. Chalgian said that reactions to the redevelopment from Trowbridge business owners were positive. Business owners expressed a high level of confidence in MSU's quality, long-term planning and achievements. Ms. Chalgian said that business owners are excited to have family-oriented housing on campus. Ms. Chalgian said that she hoped to continue to work collaboratively with MSU on future developments.

5. Personnel Actions

Provost Youatt presented the following personnel actions:

Hennessy, David A., AY - Professor, Elton R. Smith Chair in Food and Agricultural Policy, Department of Agricultural, Food and Resource Economics, \$ 206,000, with Tenure, effective August 16, 2015.

Donahue, Darrell W., AN - Professor, Department of Biosystems and Agricultural Engineering, \$ 218,000, with Tenure, effective July 1, 2015.

Long, Christopher, AN - Dean, College of Arts and Letters; Professor, Philosophy, \$ 270,000, with Tenure, effective July 1, 2015.

Fritzsche, Sonja, AN - Professor, Department of Linguistics, Germanics, Slavic, Asian, and African Languages, \$153,167, with Tenure, effective August 1, 2015.

Deliyski, Dimitar, AY - MSU Foundation Professor, Department of Communicative Sciences and Disorders, \$145,000, with Tenure, effective August 16, 2015.

Bunnell, Jane E., AY - Professor, College of Music, \$100,000, with Tenure, effective August 16, 2015.

Rasch, Randolph, AN - Dean, College of Nursing; Professor, Nursing, \$ 220,000, with Tenure, effective July 1, 2015.

Acevedo, Ignacio D., AY - Associate Professor, Department of Psychology, \$82,000, with Tenure, effective August 16, 2015.

Gade, Alexandra, AN - Professor, National Superconducting Cyclotron Laboratory; Department of Physics-Astronomy, \$169,000, with Tenure, effective July 1, 2015.

Maciel Nunes, Filomena M., AY - Professor, National Superconducting Cyclotron Laboratory; Department of Physics-Astronomy, \$118,000, with Tenure, effective August 16, 2015.

Zegers, Remco G.T., AN - Professor, National Superconducting Cyclotron Laboratory; Department of Physics-Astronomy, \$161,000, with Tenure, effective July 1, 2015.

Anastos, Thomas A., AN-Head Coach- Hockey, Intercollegiate Athletics, Subject to Contract, effective July 1, 2017 to June 30, 2018.

Hollis, Mark J., AN-Director of Intercollegiate Athletics, Subject to Contract, effective July 1, 2018 to June 30, 2019.

Izzo, Thomas, AN-Head Coach- Basketball, Intercollegiate Athletics, Subject to Contract, effective July 1, 2020 to June 30, 2021.

Rakan, Susan M. (Suzy Merchant), AN-Head Coach- Women's Basketball, Intercollegiate Athletics, Subject to Contract, effective July 1, 2018 to June 30, 2019.

Trustee Ferguson **moved to approve** the recommendations, with support from Trustee Mosallam.

**THE BOARD VOTED to approve** the resolution.

Provost Youatt presented the following personnel actions:

Gupta, Sanjay, AN—Acting Dean, Eli and Edythe Broad College of Business; Professor, Department of Accounting and Information Systems, for a change in title to Eli and Edythe Broad Dean, Eli Broad College of Business and for a change in salary to \$425,000, effective June 17, 2015.

Schmitt, Neal, AN—University Distinguished Professor Emeritus and Chairperson Emeritus, to add title of Interim Dean, College of Social Science at a salary rate of \$300,000, effective June 17, 2015.

Stoddart, Judith, AN—Associate Dean, Graduate School; Associate Professor, Department of English, for a change in title to Interim Associate Provost, Office of the Provost and Executive Vice President for Academic Affairs and Interim Dean, Graduate School and for a change in salary to \$150,000, effective June 1, 2015.

Trustee Mosallam **moved to approve** the recommendations, with support from Trustee Woodard.

**THE BOARD VOTED to approve** the resolution.

Provost Youatt recommended approval of the University Distinguished Professor designation for the ten faculty members listed below, to be effective June 17, 2015.

Roger J. Calantone	Department of Marketing
Marcos Dantus	Department of Chemistry
Joseph C. Gardiner	Department of Epidemiology and Biostatistics
Mary K. Hausbeck	Department of Plant, Soil and Microbial Sciences
Michael J. Leahy	Department of Counseling, Educational Psychology and Special Education
Linda S. Mansfield	Departments of Large Animal Clinical Sciences; Microbiology and Molecular Genetics
Hendrik Schatz	Department of Physics-Astronomy; National Superconducting Cyclotron Laboratory
Thomas D. Sharkey	Department of Biochemistry and Molecular Biology
Robert C. Smith	Departments of Medicine; Psychiatry
Michael R. Thoennesen	Department of Physics-Astronomy; National Superconducting Cyclotron Laboratory

Trustee Byrum **moved to approve** the recommendation, with support from Trustee Woodard.

**THE BOARD VOTED to approve** the resolution.

Provost Youatt presented the candidates for the awarding of tenure, effective July 1, 2015. (Appendix A)

Trustee Lyons **moved to approve** the recommendation, with support from Trustee Breslin.

**THE BOARD VOTED to approve** the resolution.

6. Gifts, Grants, and Contracts

Vice President Hsu presented the Gifts, Grants, and Contracts Report for the period March 17, 2015 through May 15, 2015. The report is a compilation of 520 Gifts, Grants and Contracts plus 43 Consignment/Non-Cash Gifts, with a total value of \$98,244,371.

Trustee Mosallam **moved to approve** the recommendation, with support from Trustee Foster.

**THE BOARD VOTED to approve** the resolution.

Vice President Hsu introduced Professor Cheryl Kerfeld, a Hannah Distinguished Professor in the Department of Biochemistry and Molecular Biology in the College of Natural Science. Professor Kerfeld made a presentation to the Board on the structural bioengineering of photosynthesis. (Appendix B)

Trustee Perles joined the meeting by telephone.

7. Finance Committee

Trustee Foster presented the Trustee Finance Committee Report and recommendations.

A. 2015-16 Budget Development Guidelines and 2016-17 Preliminary General Fund Budget Guidelines.

It was recommended that the Board of Trustees adopt the 2015-16 Budget Development Guidelines and 2016-17 Preliminary General Fund Budget Guidelines, which include revenue and expenditure totals and tuition fee rates for 2015-16 and 2016-17.

BE IT RESOLVED, the Board of Trustees adopts the 2015-16 Budget Development Guidelines (Budget Guidelines) and 2016-17 Preliminary Budget Guidelines (Preliminary Guidelines); and

BE IT FURTHER RESOLVED, that the Administration is directed to develop and implement the 2015-16 General Fund, MSU AgBioResearch, Michigan State University Extension, and Intercollegiate Athletics budgets in accordance with the Budget Guidelines and to develop the 2016-17 Budget Development Guidelines in accordance with the Preliminary Guidelines.

Trustee Perles left the meeting.

Trustee Foster **moved to approve** the recommendations, with support from Trustee Ferguson

**THE BOARD VOTED to approve** the resolution.

**Trustee Woodard voted no.**

B. University Rehabilitation Alliance Extension of Credit

It was recommended that the Board of Trustees authorize the Administration to increase its extension of credit to University Rehabilitation Alliance, Inc. ("URA"), a joint venture between Michigan State University and Peckham, Inc. ("Peckham"), a Michigan non-profit corporation.

BE IT RESOLVED, that the Board of Trustees hereby authorizes the Vice President for Finance and Treasurer to negotiate and execute appropriate documentation to increase the amount of credit available to URA from MSU by \$1.5 million, provided that Peckham provides a loan in the same amount to URA contemporaneously with MSU's extension of credit.

Trustee Foster **moved to approve** the recommendation, with support from Trustee Ferguson.

**THE BOARD VOTED to approve** the resolution.

C. New Investment Manager—Polaris Capital Management, LLC

It was recommended that the Board of Trustees select Polaris Capital Management, LLC as an investment manager in the



developed global ex U.S. asset class of the Common Investment Fund.

BE IT RESOLVED, that the Board of Trustees of Michigan State University hereby appoints Polaris Capital Management, LLC as an investment manager; and be it further

RESOLVED that the Board of Trustees (a) waives the 14 percent upper limit for the developed global ex U.S. asset class in the Investment Policy's Statement of Investment Objectives in order to enable the Administration to invest \$30 million in Polaris International Equity Fund; and (b) releases the Administration from its obligation under Section X(5) of the Investment Policy to rebalance the CIF portfolio as a consequence of this investment.

Trustee Foster **moved to approve** the recommendation, with support from Trustee Breslin.

**THE BOARD VOTED to approve** the resolution.

D. Authorization to Plan—Electrical Distribution—Upgrade Northwest Zone

It was recommended that the Board of Trustees authorize the Administration to plan for upgrading the campus electrical system on northwest campus to ensure reliability and to accommodate expansion.

BE IT RESOLVED, that the Board of Trustees of Michigan State University hereby authorizes the Administration to plan for the project entitled "Electrical Distribution—Upgrade Northwest Zone."

Trustee Foster **moved to approve** the recommendation, with support from Trustee Woodard.

**THE BOARD VOTED to approve** the resolution.

E. Authorization to Plan—Engineering Building—Alterations to Suite 1515

It was recommended that the Board of Trustees authorize the Administration to plan for the creation of a functional office environment that supports teaching and research in the newly created Department of Computational Mathematics, Science, and Engineering.

BE IT RESOLVED, that the Board of Trustees of Michigan State University hereby authorizes the Administration to plan for the project entitled "Engineering Building—Alterations to Suite 1515."

Trustee Foster **moved to approve** the recommendation, with support from Trustee Mosallam.

**THE BOARD VOTED to approve** the resolution.

- F. Authorization to Plan—Crop Science—Field Laboratory—Storage 2 (landscape change)

It was recommended that the Board of Trustees authorize the Administration to plan for an additional storage building for the Department of Plant, Soil, and Microbial Sciences.

BE IT RESOLVED, that the Board of Trustees of Michigan State University hereby authorizes the Administration to plan for the project entitled "Crop Science—Field Laboratory—Storage 2."

Trustee Foster **moved to approve** the recommendation, with support from Trustee Ferguson.

**THE BOARD VOTED to approve** the resolution.

- G. Project Approval—Authorization to Proceed—State Police Post Redevelopment

It was recommended that the Board of Trustees authorize the Administration to proceed with redevelopment of the former State Police Post site, including facilities that will replace the apartments at Spartan Village, a prerequisite to its eventual demolition.

BE IT RESOLVED, that the Board of Trustees of Michigan State University hereby authorizes the Administration to proceed with the project entitled "State Police Post Redevelopment," with a project budget of \$156,700,000; and

BE IT FURTHER RESOLVED, that the Board of Trustees of Michigan State University hereby changes the zoning district of the former State Police post from Service to Mixed-Use North and grants a variance to the University zoning ordinance to allow a modest encroachment of parking and building footprint into protected greenspace.

Trustee Foster **moved to approve** the recommendation, with support from Trustee Ferguson.

**THE BOARD VOTED to approve** the resolution.

- H. Project Approval—Authorization to Proceed—MSU College of Law—North Entrance Site Improvements (*footprint change*)

It was recommended that the Board of Trustees authorize the Administration to proceed with enhancements to the College of Law building entrance.

BE IT RESOLVED, that the Board of Trustees of Michigan State University hereby authorizes the Administration to proceed with the project entitled “MSU College of Law—North Entrance Site Improvements.”

Trustee Foster **moved to approve** the recommendation, with support from Trustee Breslin.

**THE BOARD VOTED to approve** the resolution.

- I. Project Approval—Authorization to Proceed—Crop Science—Field Laboratory—Addition 2—Greenhouse (*footprint change*)

It was recommended that the Board of Trustees authorize the Administration to proceed with an addition to the crop science field laboratory to accommodate expansion of the potato breeding and genetics program.

BE IT RESOLVED, that the Board of Trustees of Michigan State University hereby authorizes the Administration to proceed with the project entitled “Crop Science—Field Laboratory—Addition 2—Greenhouse.”

Trustee Foster **moved to approve** the recommendation, with support from Trustee Lyons.

**THE BOARD VOTED to approve** the resolution.

- J. Project Approval—Authorization to Proceed—MSU Police—Special Response Team Operations Center and MSU Police Training Facility—Computer-Based Decision Shooting System (*landscape and footprint change*)

It was recommended that the Board of Trustees authorize the Administration to (a) proceed with the construction of a building to replace the two MSU Police buildings which will be displaced from their current location at the former State Police Post site by the "State Police Post Redevelopment" project; and (b) proceed, without prior authorization to plan, with the expansion of an existing training building next to the site of the new building to achieve cost savings by undertaking the two projects concurrently.

BE IT RESOLVED, that the Board of Trustees of Michigan State University waives any requirement under Board Policy 02-06-01 that the Administration obtain authorization to plan for the project entitled "MSU Training Facility—Computer-Based Decision Shooting System," and hereby authorizes the Administration to proceed with that project; and

BE IT FURTHER RESOLVED, that the Board of Trustees of Michigan State University hereby authorizes the Administration to proceed with the project entitled "State Police Post Redevelopment."

Trustee Foster **moved to approve** the recommendation, with support from Trustee Woodard.

**THE BOARD VOTED to approve** the resolution.

K. Project Approval—Authorization to Proceed—MSU Scene Shop—Performing Arts Teaching Laboratory

It was recommended that the Board of Trustees authorize the Administration to proceed with the relocation of the MSU Scene Shop, which will be displaced from its current location at the former State Police Post site.

BE IT RESOLVED, that the Board of Trustees of Michigan State University hereby authorizes the Administration to proceed with the project entitled "MSU Scene Shop—Performing Arts Teaching Laboratory," with a project budget of \$2,400,000; and

BE IT FURTHER RESOLVED, that the Board of Trustees of Michigan State University hereby grants a variance to the University zoning ordinance to permit an academic land use within the Service District.

Trustee Foster **moved to approve** the recommendation, with support from Trustee Mosallam.

**THE BOARD VOTED to approve** the resolution.

- L. Project Approval—Authorization to Proceed—Natural Gas Distribution—New Pipeline from Mt. Hope Road

It was recommended that the Board of Trustees authorize the Administration to proceed with installation of a second natural gas line to connect the T.B. Simon Power Plant to the Consumers Energy main gas distribution line along Mt. Hope Road.

BE IT RESOLVED, that the Board of Trustees of Michigan State University hereby authorizes the Administration to proceed with the project entitled "Natural Gas Distribution—New Pipeline from Mt. Hope," with a project budget of \$3,450,000.

Trustee Foster **moved to approve** the recommendation, with support from Trustee Ferguson

**THE BOARD VOTED to approve** the resolution.

- 8. Policy Committee

Trustee Byrum presented the Trustee Policy Committee Report and recommendations.

- A. Naming Proposal: Detroit College of Law Plaza

It was recommended that the Board of Trustees name the north entrance plaza to the Michigan State University College of Law building the Detroit College of Law Plaza.

BE IT RESOLVED, that the north entrance plaza to the Michigan State University College of Law building, presented to the Board of Trustees for authorization to proceed on June 17, 2015, be named Detroit College of Law Plaza.

Trustee Byrum **moved to approve** the recommendation, with support from Trustee Lyons.

**THE BOARD VOTED to approve** the resolution.

- B. Naming Proposal: Lasch Family Golf Center

It was recommended that the Board of Trustees name the men's and women's golf facility at Forest Akers West Golf Course the Lasch Family Golf Center.

BE IT RESOLVED, that the men's and women's golf facility at Forest Akers West Golf Course, presented to the Board of Trustees for Authorization to Proceed on February 6, 2015, be named the Lasch Family Golf Center.

Trustee Byrum **moved to approve** the recommendation, with support from Trustee Ferguson.

**THE BOARD VOTED to approve** the resolution.

C. Smoking Ordinance Amendment

It was recommended that the Board of Trustees amend and modify Board Ordinance 29.00, Smoking, Use and Sale of Tobacco Products, to prohibit smoking and the use of tobacco products on campus, effective August 15, 2016.

BE IT RESOLVED, that the Board of Trustees amends Board Ordinance 29.00 Smoking, Use and Sale of Tobacco Products as shown in Attachment A, effective August 15, 2016. (Appendix C)

Trustee Byrum **moved to approve** the recommendation, with support from Trustee Mosallam.

**THE BOARD VOTED to approve** the resolution.

D. Amendment of Ordinance 35.00 (Administration—Traffic) to Add Taxicab Regulation

It was recommended that the Board of Trustees adopt an ordinance regulating the operation of taxicabs and other vehicles for hire on campus.

BE IT RESOLVED, that the Board of Trustees hereby amends University Ordinance 35.00 (Administration –Traffic) by adding the language in Exhibit A attached hereto as section 35.50 thereof. (Appendix D)

Trustee Byrum **moved to approve** the recommendation, with support from Trustee Mosallam.

**THE BOARD VOTED to approve** the resolution.

E. Proposed Creation of an Institute for Integrative Toxicology

It was recommended that the Board of Trustees re-constitute the existing Center for Integrative Toxicology, re-naming and re-establishing the unit as the Institute for Integrative Toxicology.

BE IT RESOLVED, that the Board of Trustees hereby establishes the Institute for Integrative Toxicology, superseding and subsuming the previous Center for Integrative Toxicology, with immediate effect.

Trustee Byrum **moved to approve** the recommendation, with support from Trustee Mosallam.

**THE BOARD VOTED to approve** the resolution.

F. Approval of Contract Terms

It was recommended that the Board of Trustees approve a contract between Michigan State University and *Bioplastic Polymers and Composites, LLC*, a company in which faculty member Dr. Ramani Narayan holds a financial interest.

BE IT RESOLVED, that the Board of Trustees of Michigan State University hereby approves an option extension agreement with *Bioplastic Polymers and Composites, LLC*, consistent with earlier public notice given at a Board meeting and with an "Option Extension Agreement Term Sheet" presented to the Board. (Appendix E)

It was recommended that the Board of Trustees approve a contract between Michigan State University and *BoroPharm, Inc.* a company in which faculty members Dr. Robert E. Maleczka and Dr. Milton R. Smith hold a financial interest.

BE IT RESOLVED, that the Board of Trustees of Michigan State University hereby approves a lease with *BoroPharm, Inc.*, consistent with earlier public notice given at a Board meeting and with the "Lease Term Sheet" presented to the Board. (Appendix F)

It was recommended that the Board of Trustees approve a contract between Michigan State University and *HAO Tech, LLC*, a company in which faculty member Dr. Gouliang Xing holds a financial interest.

BE IT RESOLVED, that the Board of Trustees of Michigan State University hereby approves a revised license agreement with *HAO Tech, LLC*, consistent with earlier public notice given at a Board meeting and with the "Revised License Agreement Term Sheet" presented to the Board. (Appendix G)

It was recommended that the Board of Trustees approve a contract between Michigan State University and *Metna Corporation*, a company in which faculty member Dr. Parvis Soroushian holds a financial interest.

BE IT RESOLVED, that the Board of Trustees of Michigan State University hereby approves a sponsored research agreement with *Metna Corporation*, consistent with earlier public notice given at a Board meeting and with the "Sponsored Research Agreement Term Sheet" presented to the Board. (Appendix H)

It was recommended that the Board of Trustees approve a contract between Michigan State University and *QuantumBio, Inc.*, a company in which faculty member Dr. Kenneth M. Merz, Jr. holds a financial interest.

BE IT RESOLVED, that the Board of Trustees of Michigan State University hereby approves a sponsored research agreement with *QuantumBio, Inc.*, consistent with earlier public notice given at a Board meeting and with the "Sponsored Research Agreement Term Sheet" presented to the Board. (Appendix I)

It was recommended that the Board of Trustees approve a contract between Michigan State University and *QuantumBio, Inc.*, a company in which faculty member Dr. Kenneth M. Merz, Jr. holds a financial interest.

BE IT RESOLVED, that the Board of Trustees of Michigan State University hereby approves a sponsored research agreement and deployment agreement with *QuantumBio, Inc.*, consistent with earlier public notice given at a Board meeting and with the "Sponsored Research and Deployment Agreement Term Sheet" presented to the Board. (Appendix J)



It was recommended that the Board of Trustees approve a contract between Michigan State University and *QuantumBio, Inc.*, a company in which faculty member Dr. Kenneth M. Merz, Jr. holds a financial interest.

BE IT RESOLVED, that the Board of Trustees of Michigan State University hereby approves a sponsored research development and deployment agreement with *QuantumBio, Inc.*, consistent with earlier public notice given at a Board meeting and with the “Sponsored Research Development and Deployment Agreement Term Sheet” presented to the Board. (Appendix K)

It was recommended that the Board of Trustees approve a contract between Michigan State University and *Supremo*, a Michigan sole proprietorship owned by faculty member Dr. Jan Eberle, a professor in the Department of Music.

BE IT RESOLVED, that the Board of Trustees of Michigan State University hereby approves a purchase agreement with *Supremo*, consistent with earlier public notice given at a Board meeting and with the “Purchase Agreement Term Sheet” presented to the Board. (Appendix L)

Trustee Byrum **moved to approve** the recommendations, with support from Trustee Lyons.

**THE BOARD VOTED to approve** the resolutions.

G. Notice of Intent to Negotiate Contracts

Pursuant to State law, Trustee Byrum gave public notice of the University’s intent to negotiate contracts with *Alphabet Energy, Inc.*, a California corporation. Dr. Donald T. Morelli, a Professor in the Department of Chemical Engineering & Material Science, and members of his family have, or have options to buy, an interest in the company.

9. Trustee Comments

Trustee Ferguson stated that MSU does more with less and that the Board can disagree without being disagreeable.

Trustee Woodard thanked President Simon for her leadership.

Trustee Mosallam thanked Vice President Beekman and Dave Byelich for their work on the budget process. Trustee Mosallam congratulated Dean Gupta and thanked the Lasch family for its generous donation.

Trustee Foster said that everyone continues to work together to make MSU a great investment and a great value.

Trustee Byrum said that she was excited about the upcoming groundbreaking of the MSU Medical Research Building in Grand Rapids.

Trustee Breslin thanked his colleagues for the robust discussion regarding tuition.

Trustee Lyons welcomed Dean Gupta and thanked the Skandalaris and Lasch families for their donations.

10. Public Participation on Issues Not Germane to the Agenda.

A. Diversity/Faculty Retention

William Terrill, MSU professor of Criminal Justice, said that he and his wife were recently recruited by the University of Arizona. Professor Terrill said that he provided the written offer to the Department and was told that he and his wife should accept the offer. Professor Terrill acknowledged that improvements could be made and that he and his wife have worked diligently to improve the status of the program. Professor Terrill said that the Board should demand greater accountability from departments across campus.

B. Football Tailgating

Greg Farnsworth, MSU community member, said that high-level athletes have been recruited to MSU due to the family atmosphere. Mr. Farnsworth noted that the family atmosphere disappears on game days when some tailgaters take advantage of MSU's loose alcohol policy. The campus is no longer family friendly. Mr. Farnsworth stated that the tailgating rules are not followed by many fans. Mr. Farnsworth suggested that tailgating lots open four hours prior to kick-off, that a buffer zone be created around the stadium where no drinking is allowed, and that announcements be played within Spartan Stadium reminding fans to act responsibly.

11. Request to Adjourn

On a motion by Trustee Ferguson, supported by Trustee Woodard, **THE BOARD VOTED to adjourn** at 1:00 p.m.

Respectfully submitted,



William R. Beekman  
Vice President and Secretary of the Board of Trustees

**MICHIGAN STATE  
UNIVERSITY**

The following actions which include the award of tenure are recommended to be effective July 1, 2015

**Promotion to Associate Professor, Effective July 1, 2015**

**10002000 - COLLEGE OF AGRICULTURE & NAT RESOURCES**

Name	Organization Name	Tenure Department	Also Reports To Organization Name(s)
Ross, Robert Brent	AGRICULTURAL, FOOD & RESOURCE ECONOMICS	AGRICULTURAL, FOOD & RESOURCE ECONOMICS	AG FOOD RESOURCE ECON MABR
Rowntree, Jason Edward	ANIMAL SCIENCE DEPARTMENT - ANR	ANIMAL SCIENCE DEPARTMENT - ANR	ANIMAL SCIENCE DEPARTMENT MABR, ANIMAL SCIENCE DEPARTMENT - MSUE
McCole, Daniel Timothy	DEPARTMENT OF COMMUNITY SUSTAINABILITY	DEPARTMENT OF COMMUNITY SUSTAINABILITY	DEPARTMENT OF COMMUNITY SUSTAINABILITY, DEPARTMENT OF COMMUNITY SUSTAINABILITY
Benbow, Mark Eric	ENTOMOLOGY AGRICULTURE AND NATURAL RES	ENTOMOLOGY AGRICULTURE AND NATURAL RES	OSTEOPATHIC MEDICAL SPECIALTIES COM, ENTOMOLOGY MABR
Szendrei, Zsolt Ildiko	ENTOMOLOGY AGRICULTURE AND NATURAL RES	ENTOMOLOGY AGRICULTURE AND NATURAL RES	ENTOMOLOGY MABR, ENTOMOLOGY MSUE
Almenar Rosaleny, Eva Maria	PACKAGING	PACKAGING	

**10004000 - COLLEGE OF ARTS AND LETTERS**

Name	Organization Name	Tenure Department	Also Reports To Organization Name(s)
Claytor, Candace Mae	ART, ART HISTORY, AND DESIGN	ART, ART HISTORY, AND DESIGN	RESIDENTIAL COLLEGE ARTS & HUMAN DEAN
Kotula, Paul S	ART, ART HISTORY, AND DESIGN	ART, ART HISTORY, AND DESIGN	
Winge, Theresa M	ART, ART HISTORY, AND DESIGN	ART, ART HISTORY, AND DESIGN	
Zitzewitz, Karln Jane	ART, ART HISTORY, AND DESIGN	ART, ART HISTORY, AND DESIGN	
Yumibe, Joshua	ENGLISH	ENGLISH	
Spinner, Patricia Ann	LINGUISTICS, GERM, SLAVIC, ASIAN, AFR LANG	LINGUISTICS, GERM, SLAVIC, ASIAN, AFR LANG	
Wagner, Suzanne Louise	LINGUISTICS, GERM, SLAVIC, ASIAN, AFR LANG	LINGUISTICS, GERM, SLAVIC, ASIAN, AFR LANG	
Whyte, Kyle Powys	PHILOSOPHY	PHILOSOPHY	
Dobblin, Alison Clare	THEATRE	THEATRE	

**10006000 - ARTS & HUMANITIES, RESIDENTIAL COLL IN**

Name	Organization Name	Tenure Department	Also Reports To Organization Name(s)
Torrez, Jessica Starr	RESIDENTIAL COLLEGE ARTS & HUMAN DEAN	RESIDENTIAL COLLEGE ARTS & HUMAN DEAN	
Yoder, Scot D	RESIDENTIAL COLLEGE ARTS & HUMAN DEAN	RESIDENTIAL COLLEGE ARTS & HUMAN DEAN	

**10008000 - ELI BROAD COLLEGE OF BUSINESS**

Name	Organization Name	Tenure Department	Also Reports To Organization Name(s)
Yun, Hayong	FINANCE	FINANCE	

**10010000 - COLLEGE OF COMMUNICATION ARTS SCIENCES**

MSU is an affirmative-action, equal-opportunity employer.

**MICHIGAN STATE  
UNIVERSITY**

The following actions which include the award of tenure are recommended to be effective July 1, 2015

**Promotion to Associate Professor, Effective July 1, 2015**

Name	Organization Name	Tenure Department	Also Reports To Organization Name(s)
ODonnell, Casey Keohane	DEPARTMENT OF MEDIA AND INFORMATION	DEPARTMENT OF MEDIA AND INFORMATION	
Wash, Richard Lawrence	JOURNALISM	JOURNALISM	DEPARTMENT OF MEDIA AND INFORMATION

**10014000 - COLLEGE OF EDUCATION**

Name	Organization Name	Tenure Department	Also Reports To Organization Name(s)
Fine, Jodene G	COUNSELING, EDUC PSYCH & SPEC EDUC	COUNSELING, EDUC PSYCH & SPEC EDUC	
Bartell, Tonya R	TEACHER EDUCATION	TEACHER EDUCATION	

**10016000 - COLLEGE OF ENGINEERING**

Name	Organization Name	Tenure Department	Also Reports To Organization Name(s)
Hodge, David	CHEMICAL ENGINEERING & MATERIALS SCIENCE	CHEMICAL ENGINEERING & MATERIALS SCIENCE	BIOSYSTEMS & AGRICULTURAL ENGINEERING
Lajnef, Nizar	CIVIL & ENVIRONMENTAL ENGINEERING	CIVIL & ENVIRONMENTAL ENGINEERING	ELECTRICAL AND COMPUTER ENGINEERING
Sun, Yanni	COMPUTER SCIENCE AND ENGINEERING	COMPUTER SCIENCE AND ENGINEERING	
Chahal, Prem J	ELECTRICAL AND COMPUTER ENGINEERING	ELECTRICAL AND COMPUTER ENGINEERING	
Dong, Lixin	ELECTRICAL AND COMPUTER ENGINEERING	ELECTRICAL AND COMPUTER ENGINEERING	
Li, Wen	ELECTRICAL AND COMPUTER ENGINEERING	ELECTRICAL AND COMPUTER ENGINEERING	
Sepulveda Alancastro, Nelson	ELECTRICAL AND COMPUTER ENGINEERING	ELECTRICAL AND COMPUTER ENGINEERING	

**10022000 - COLLEGE OF HUMAN MEDICINE**

Name	Organization Name	Tenure Department	Also Reports To Organization Name(s)
Luo, Zhehui	EPIDEMIOLOGY AND BIostatISTICS	EPIDEMIOLOGY AND BIostatISTICS	
Andrechek, Eran Robert	PHYSIOLOGY HUMAN MEDICINE	PHYSIOLOGY HUMAN MEDICINE	

**10028000 - LYMAN BRIGGS COLLEGE**

Name	Organization Name	Tenure Department	Also Reports To Organization Name(s)
Bellon, Richard D	LYMAN BRIGGS DEAN	LYMAN BRIGGS DEAN	HISTORY
Montgomery, Georgina Mary	LYMAN BRIGGS DEAN	LYMAN BRIGGS DEAN	HISTORY
Wake, Naoko	LYMAN BRIGGS DEAN	LYMAN BRIGGS DEAN	INTERNATIONAL STUDIES & PROGRAMS DEAN, HISTORY

**10032000 - COLLEGE OF NATURAL SCIENCE**

Name	Organization Name	Tenure Department	Also Reports To Organization Name(s)
Hedden,	MATHEMATICS	MATHEMATICS	

MSU is an affirmative-action, equal-opportunity employer.

**MICHIGAN STATE  
UNIVERSITY**

The following actions which include the award of tenure are recommended to be effective July 1, 2015

<b>Promotion to Associate Professor, Effective July 1, 2015</b>			
Name	Organization Name	Tenure Department	Also Reports To Organization Name(s)
Matthew Edward			
Schmidt, Benjamin I	MATHEMATICS	MATHEMATICS	
Zhang, Pengpeng	PHYSICS-ASTRONOMY	PHYSICS-ASTRONOMY	
<b>10033000 - COLLEGE OF NURSING</b>			
Name	Organization Name	Tenure Department	Also Reports To Organization Name(s)
Hoffman, Amy Jude	NURSING	NURSING	
Lehto, Rebecca Helen	NURSING	NURSING	
<b>10038000 - COLLEGE OF SOCIAL SCIENCE</b>			
Name	Organization Name	Tenure Department	Also Reports To Organization Name(s)
Fujita, Masako	ANTHROPOLOGY SOCIAL SCIENCE	ANTHROPOLOGY SOCIAL SCIENCE	
Cobbina, Jennifer Ernestina	CRIMINAL JUSTICE	CRIMINAL JUSTICE	
Zeoli, April Marie	CRIMINAL JUSTICE	CRIMINAL JUSTICE	CRIMINAL JUSTICE MABR
Anderson, Soren Tyler	ECONOMICS	ECONOMICS	AGRICULTURAL, FOOD & RESOURCE ECONOMICS
Doblas Madrid, Antonio	ECONOMICS	ECONOMICS	
Ligmann-Zielinska, Arka	GEOGRAPHY	GEOGRAPHY	ENVIRONMENTAL SCIENCE AND POLICY PROGRAM
Luo, Lufeng	GEOGRAPHY	GEOGRAPHY	
Moore, Nathan Jacob	GEOGRAPHY	GEOGRAPHY	GLOBAL CHG & EARTH OBSERVATIONS, CTR FOR
Pauly, Matthew Denalf	HISTORY	HISTORY	
Veit, Helen Elizabeth	HISTORY	HISTORY	
Vallotton, Claire D	HUMAN DEVELOPMENT & FAMILY STUDIES - CSS	HUMAN DEVELOPMENT & FAMILY STUDIES - CSS	
Bodea, Ana Maria Cristina	POLITICAL SCIENCE	POLITICAL SCIENCE	
Moser, Jason Scot	PSYCHOLOGY SOCIAL SCIENCE	PSYCHOLOGY SOCIAL SCIENCE	
Neal, Jennifer Renee Watling	PSYCHOLOGY SOCIAL SCIENCE	PSYCHOLOGY SOCIAL SCIENCE	

**MICHIGAN STATE  
UNIVERSITY**

The following actions which include the award of tenure are recommended to be effective July 1, 2015

**Promotion to Associate Professor, Effective July 1, 2015**

Name	Organization Name	Tenure Department	Also Reports To Organization Name(s)
Yan, Lili	PSYCHOLOGY SOCIAL SCIENCE	PSYCHOLOGY SOCIAL SCIENCE	
Kassens Noor, Eva	SCHOOL OF PLANNING,DES&CONSTRUCTION-CSS	SCHOOL OF PLANNING,DES&CONSTRUCTION-CSS	SCHOOL OF PLANNING,DES,CONSTRUCTION- ANR, GLOBAL URBAN STUDIES
Hughes, Anne Katrin	SOCIAL WORK	SOCIAL WORK	

**MICHIGAN STATE  
UNIVERSITY**

The following actions which include the award of tenure are recommended to be effective July 1, 2015

<b>Associate Professors Who Acquire Tenure with the Reappointment, Effective July 1, 2015</b>			
<b>10008000 - ELI BROAD COLLEGE OF BUSINESS</b>			
Name	Organization Name	Tenure Department	Also Reports To Organization Name(s)
Susarla, Anjana	ACCOUNTING AND INFORMATION SYSTEMS	ACCOUNTING AND INFORMATION SYSTEMS	
<b>10034000 - COLLEGE OF OSTEOPATHIC MEDICINE</b>			
Name	Organization Name	Tenure Department	Also Reports To Organization Name(s)
Carlson, Joseph J	RADIOLOGY OSTEOPATHIC MEDICINE	RADIOLOGY OSTEOPATHIC MEDICINE	
Shapiro, Erik Marcellus	RADIOLOGY OSTEOPATHIC MEDICINE	RADIOLOGY OSTEOPATHIC MEDICINE	RADIOLOGY HUMAN MEDICINE



**RESEARCH  
PRESENTATION**  
TO THE MSU BOARD OF TRUSTEES

**JUNE 17, 2015**

**CHERYL KERFELD**  
**COLLEGE OF NATURAL SCIENCE**

Facilitated by the Office of the Vice President for  
Research and Graduate Studies

**Cheryl A. Kerfeld** is the Hannah Distinguished Professor of Structural Bioengineering in the DOE Plant Research Laboratory and the Department of Biochemistry and Molecular Biology at Michigan State University. She also holds appointments with the Physical Biosciences Division of Lawrence Berkeley National Laboratory and the Berkeley Synthetic Biology Institute. Her research group focuses on structure-based characterization and engineering of photoprotection and the carbon concentrating mechanism in cyanobacteria; her group is also developing bacterial microcompartment-based systems for metabolic engineering. The Kerfeld group combines methods in bioinformatics, cellular imaging, synthetic and structural biology for the engineering bacterial metabolism. Cheryl received her BA in Biology and English from the University of Minnesota, has a Master's in English Literature from the University of Minnesota via Regents' Scholars Program and a PhD in Biology from UCLA.

# Structural Bioengineering of Photosynthesis

Cheryl Kerfeld  
MSU-DOE Plant Research Lab  
Department of Biochemistry and  
Molecular Biology



## Bioengineering of Photosynthesis



<http://her.ksa.msu.edu/2012/07/25/25-her-regular-farm-just-way-for-farmers-to-participate-in-carbon-markets/>

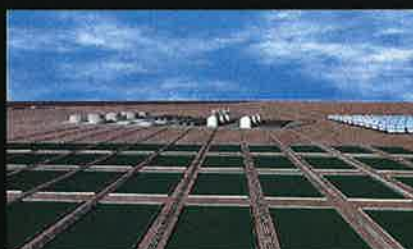

[http://images.businessweek.com/ss/09/04/0416\\_biofuel17.htm](http://images.businessweek.com/ss/09/04/0416_biofuel17.htm)



<http://www.algaeindustryimagazine.com/a-i-m-interview-algenols-ceo-paul-woods/>



<http://spew02.fhogapoc.com/2011/10/blue-green-algae-cyanobacteria.html>



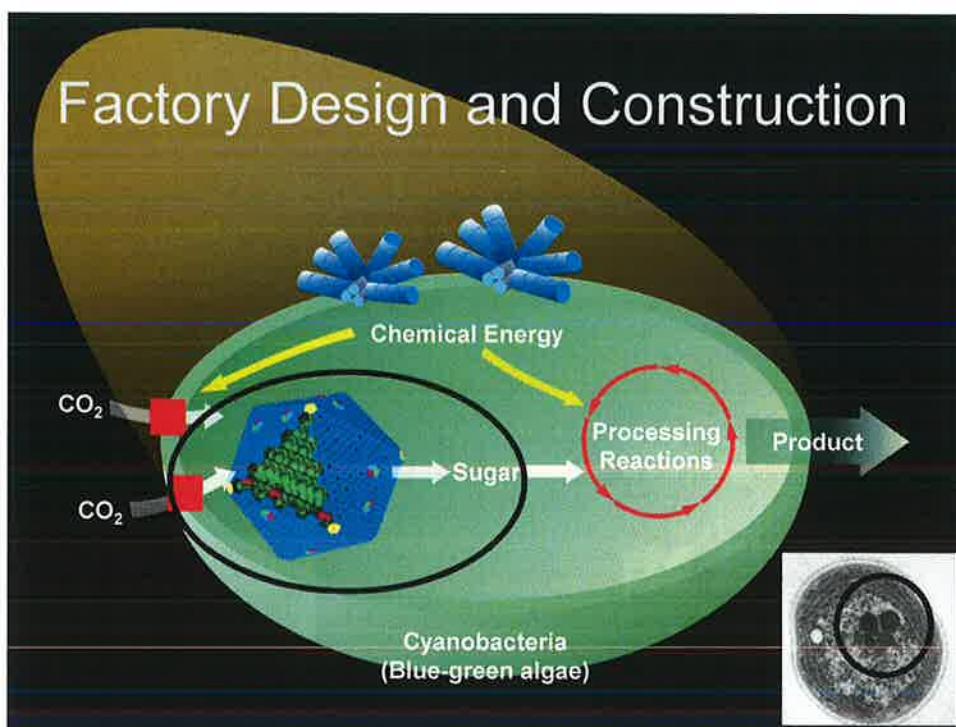
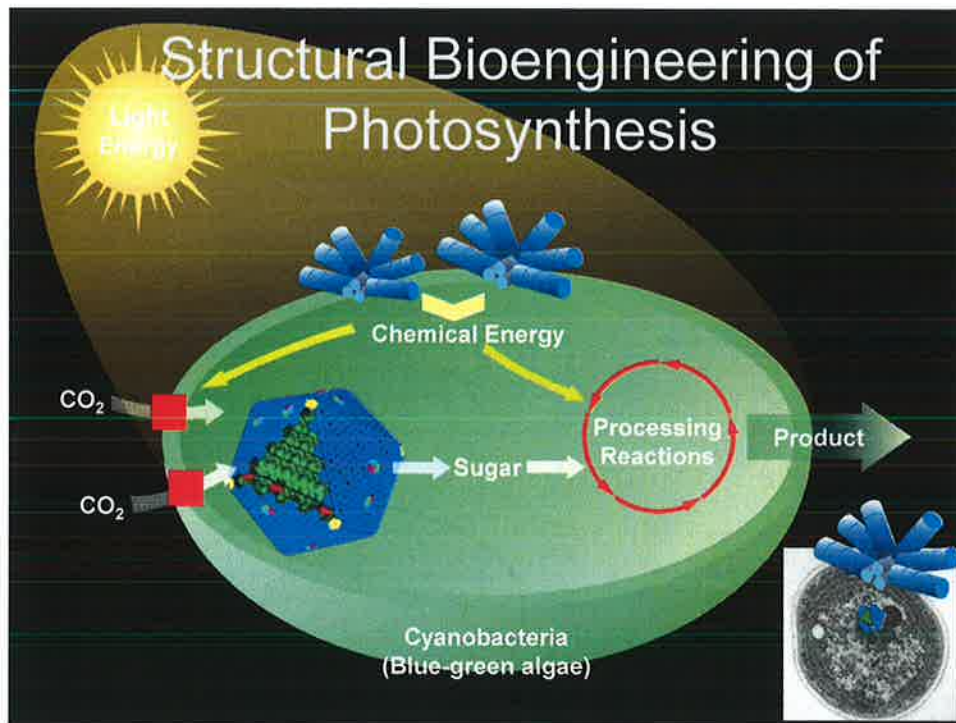



# Characterizing the Building Blocks

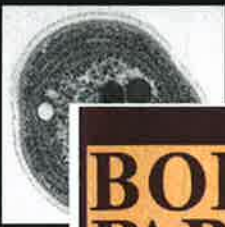
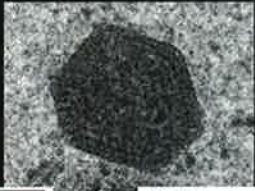
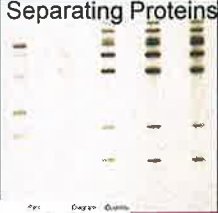



## BODY PARTS LIST

*Libra*  
 PASSENGER AND COMMERCIAL CAB  
 1933 and 1934  
 Body Photographs Apply to Four Model Years

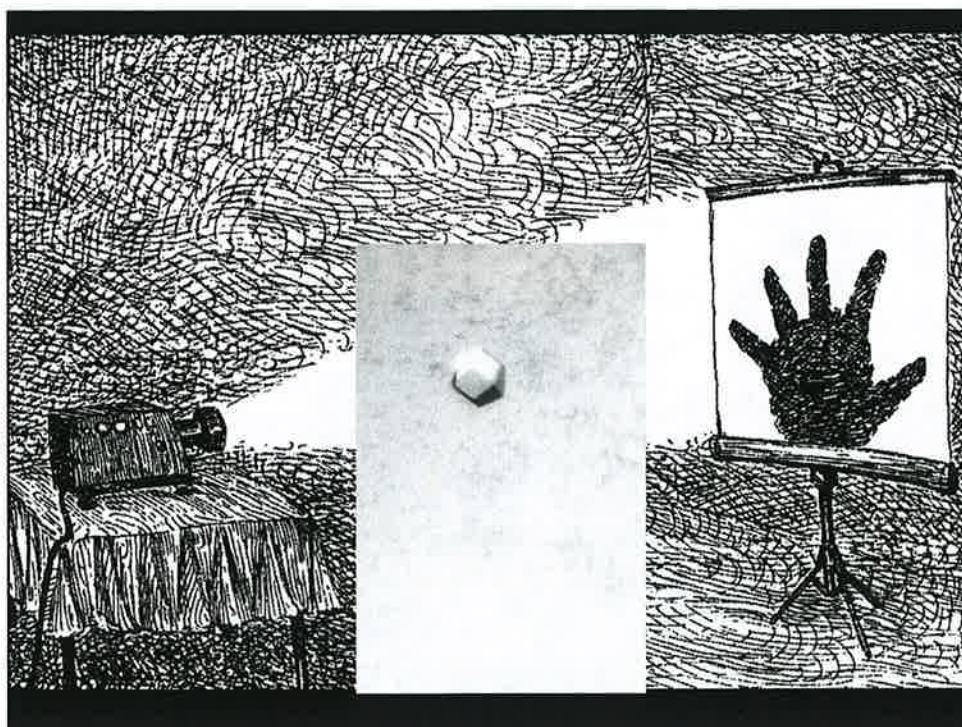
Part Number	Part Name	Qty	Diagram Number
752-1489	WALL PANEL ASSEMBLY (INCLUDES 104 AND 105) (20)	1	1
752-1492	MUFFLER COVER ASSEMBLY (INCLUDES 1 AND 2)	1	1
751-14048	AIR CLEANER FILTER	1	2
751-14049	EXHAUST SYSTEM (INCLUDES 1 AND 2)	1	3
751-14051	EXHAUST PLATE	1	4
751-14052	EXHAUST SYSTEM (INCLUDES 1 AND 2)	1	5
751-14053	EXHAUST SYSTEM (INCLUDES 1 AND 2)	1	6
751-14054	EXHAUST SYSTEM (INCLUDES 1 AND 2)	1	7
751-14055	EXHAUST SYSTEM (INCLUDES 1 AND 2)	1	8
751-14056	EXHAUST SYSTEM (INCLUDES 1 AND 2)	1	9
751-14057	EXHAUST SYSTEM (INCLUDES 1 AND 2)	1	10
751-14058	EXHAUST SYSTEM (INCLUDES 1 AND 2)	1	11
751-14059	EXHAUST SYSTEM (INCLUDES 1 AND 2)	1	12
751-14060	EXHAUST SYSTEM (INCLUDES 1 AND 2)	1	13
751-14061	EXHAUST SYSTEM (INCLUDES 1 AND 2)	1	14
751-14062	EXHAUST SYSTEM (INCLUDES 1 AND 2)	1	15
751-14063	EXHAUST SYSTEM (INCLUDES 1 AND 2)	1	16
751-14064	EXHAUST SYSTEM (INCLUDES 1 AND 2)	1	17
751-14065	EXHAUST SYSTEM (INCLUDES 1 AND 2)	1	18
751-14066	EXHAUST SYSTEM (INCLUDES 1 AND 2)	1	19
751-14067	EXHAUST SYSTEM (INCLUDES 1 AND 2)	1	20
751-14068	EXHAUST SYSTEM (INCLUDES 1 AND 2)	1	21
751-14069	EXHAUST SYSTEM (INCLUDES 1 AND 2)	1	22
751-14070	EXHAUST SYSTEM (INCLUDES 1 AND 2)	1	23
751-14071	EXHAUST SYSTEM (INCLUDES 1 AND 2)	1	24
751-14072	EXHAUST SYSTEM (INCLUDES 1 AND 2)	1	25
751-14073	EXHAUST SYSTEM (INCLUDES 1 AND 2)	1	26
751-14074	EXHAUST SYSTEM (INCLUDES 1 AND 2)	1	27
751-14075	EXHAUST SYSTEM (INCLUDES 1 AND 2)	1	28
751-14076	EXHAUST SYSTEM (INCLUDES 1 AND 2)	1	29
751-14077	EXHAUST SYSTEM (INCLUDES 1 AND 2)	1	30
751-14078	EXHAUST SYSTEM (INCLUDES 1 AND 2)	1	31
751-14079	EXHAUST SYSTEM (INCLUDES 1 AND 2)	1	32
751-14080	EXHAUST SYSTEM (INCLUDES 1 AND 2)	1	33
751-14081	EXHAUST SYSTEM (INCLUDES 1 AND 2)	1	34
751-14082	EXHAUST SYSTEM (INCLUDES 1 AND 2)	1	35
751-14083	EXHAUST SYSTEM (INCLUDES 1 AND 2)	1	36
751-14084	EXHAUST SYSTEM (INCLUDES 1 AND 2)	1	37
751-14085	EXHAUST SYSTEM (INCLUDES 1 AND 2)	1	38
751-14086	EXHAUST SYSTEM (INCLUDES 1 AND 2)	1	39
751-14087	EXHAUST SYSTEM (INCLUDES 1 AND 2)	1	40
751-14088	EXHAUST SYSTEM (INCLUDES 1 AND 2)	1	41
751-14089	EXHAUST SYSTEM (INCLUDES 1 AND 2)	1	42
751-14090	EXHAUST SYSTEM (INCLUDES 1 AND 2)	1	43
751-14091	EXHAUST SYSTEM (INCLUDES 1 AND 2)	1	44
751-14092	EXHAUST SYSTEM (INCLUDES 1 AND 2)	1	45
751-14093	EXHAUST SYSTEM (INCLUDES 1 AND 2)	1	46
751-14094	EXHAUST SYSTEM (INCLUDES 1 AND 2)	1	47
751-14095	EXHAUST SYSTEM (INCLUDES 1 AND 2)	1	48
751-14096	EXHAUST SYSTEM (INCLUDES 1 AND 2)	1	49
751-14097	EXHAUST SYSTEM (INCLUDES 1 AND 2)	1	50
751-14098	EXHAUST SYSTEM (INCLUDES 1 AND 2)	1	51
751-14099	EXHAUST SYSTEM (INCLUDES 1 AND 2)	1	52
751-14100	EXHAUST SYSTEM (INCLUDES 1 AND 2)	1	53
751-14101	EXHAUST SYSTEM (INCLUDES 1 AND 2)	1	54
751-14102	EXHAUST SYSTEM (INCLUDES 1 AND 2)	1	55
751-14103	EXHAUST SYSTEM (INCLUDES 1 AND 2)	1	56
751-14104	EXHAUST SYSTEM (INCLUDES 1 AND 2)	1	57
751-14105	EXHAUST SYSTEM (INCLUDES 1 AND 2)	1	58
751-14106	EXHAUST SYSTEM (INCLUDES 1 AND 2)	1	59
751-14107	EXHAUST SYSTEM (INCLUDES 1 AND 2)	1	60
751-14108	EXHAUST SYSTEM (INCLUDES 1 AND 2)	1	61
751-14109	EXHAUST SYSTEM (INCLUDES 1 AND 2)	1	62
751-14110	EXHAUST SYSTEM (INCLUDES 1 AND 2)	1	63
751-14111	EXHAUST SYSTEM (INCLUDES 1 AND 2)	1	64
751-14112	EXHAUST SYSTEM (INCLUDES 1 AND 2)	1	65
751-14113	EXHAUST SYSTEM (INCLUDES 1 AND 2)	1	66
751-14114	EXHAUST SYSTEM (INCLUDES 1 AND 2)	1	67
751-14115	EXHAUST SYSTEM (INCLUDES 1 AND 2)	1	68
751-14116	EXHAUST SYSTEM (INCLUDES 1 AND 2)	1	69
751-14117	EXHAUST SYSTEM (INCLUDES 1 AND 2)	1	70
751-14118	EXHAUST SYSTEM (INCLUDES 1 AND 2)	1	71
751-14119	EXHAUST SYSTEM (INCLUDES 1 AND 2)	1	72
751-14120	EXHAUST SYSTEM (INCLUDES 1 AND 2)	1	73
751-14121	EXHAUST SYSTEM (INCLUDES 1 AND 2)	1	74
751-14122	EXHAUST SYSTEM (INCLUDES 1 AND 2)	1	75
751-14123	EXHAUST SYSTEM (INCLUDES 1 AND 2)	1	76
751-14124	EXHAUST SYSTEM (INCLUDES 1 AND 2)	1	77
751-14125	EXHAUST SYSTEM (INCLUDES 1 AND 2)	1	78
751-14126	EXHAUST SYSTEM (INCLUDES 1 AND 2)	1	79
751-14127	EXHAUST SYSTEM (INCLUDES 1 AND 2)	1	80
751-14128	EXHAUST SYSTEM (INCLUDES 1 AND 2)	1	81
751-14129	EXHAUST SYSTEM (INCLUDES 1 AND 2)	1	82
751-14130	EXHAUST SYSTEM (INCLUDES 1 AND 2)	1	83
751-14131	EXHAUST SYSTEM (INCLUDES 1 AND 2)	1	84
751-14132	EXHAUST SYSTEM (INCLUDES 1 AND 2)	1	85
751-14133	EXHAUST SYSTEM (INCLUDES 1 AND 2)	1	86
751-14134	EXHAUST SYSTEM (INCLUDES 1 AND 2)	1	87
751-14135	EXHAUST SYSTEM (INCLUDES 1 AND 2)	1	88
751-14136	EXHAUST SYSTEM (INCLUDES 1 AND 2)	1	89
751-14137	EXHAUST SYSTEM (INCLUDES 1 AND 2)	1	90
751-14138	EXHAUST SYSTEM (INCLUDES 1 AND 2)	1	91
751-14139	EXHAUST SYSTEM (INCLUDES 1 AND 2)	1	92
751-14140	EXHAUST SYSTEM (INCLUDES 1 AND 2)	1	93
751-14141	EXHAUST SYSTEM (INCLUDES 1 AND 2)	1	94
751-14142	EXHAUST SYSTEM (INCLUDES 1 AND 2)	1	95
751-14143	EXHAUST SYSTEM (INCLUDES 1 AND 2)	1	96
751-14144	EXHAUST SYSTEM (INCLUDES 1 AND 2)	1	97
751-14145	EXHAUST SYSTEM (INCLUDES 1 AND 2)	1	98
751-14146	EXHAUST SYSTEM (INCLUDES 1 AND 2)	1	99
751-14147	EXHAUST SYSTEM (INCLUDES 1 AND 2)	1	100

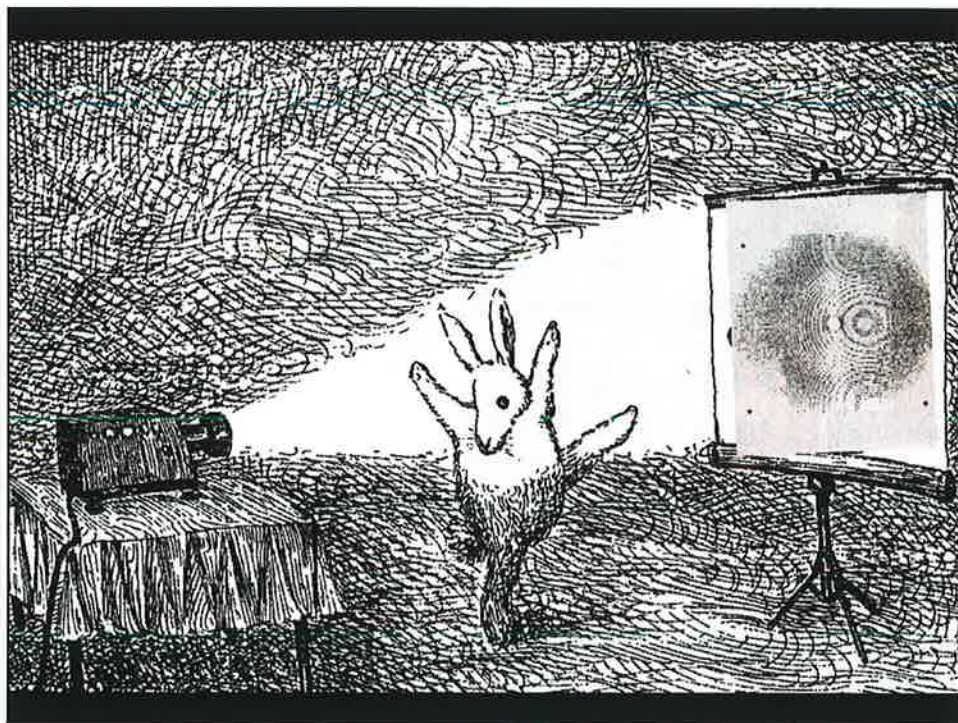



## Characterizing the Building Blocks

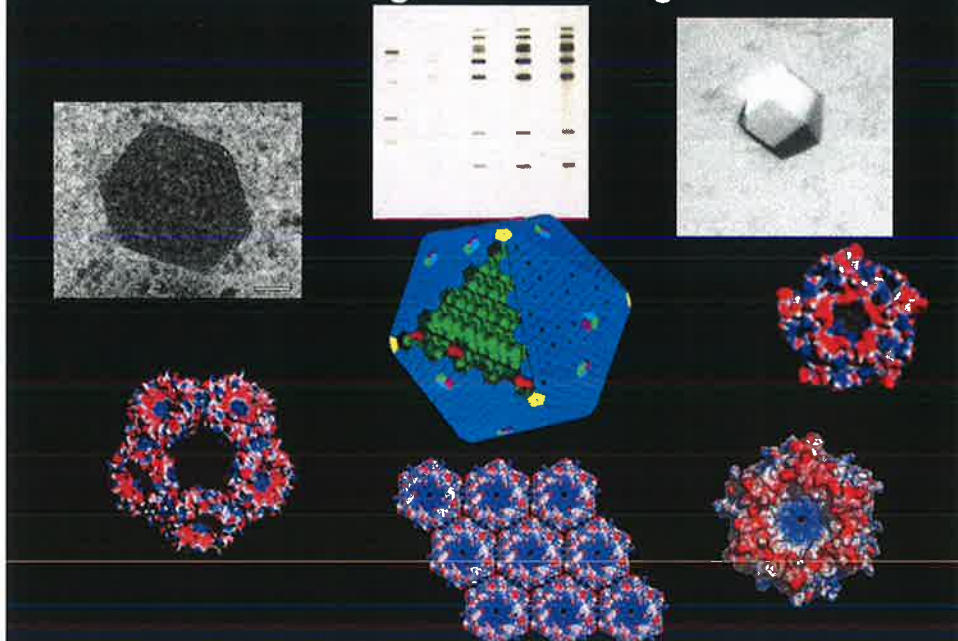



# Assembling the Parts

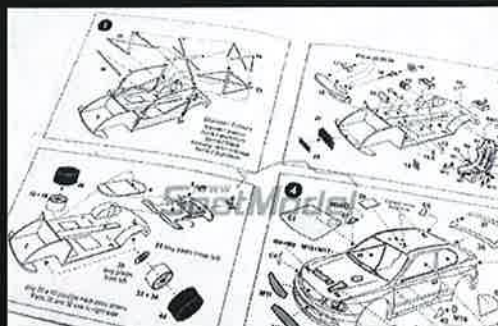

Enzymes (machinery)



Shell (factory walls)

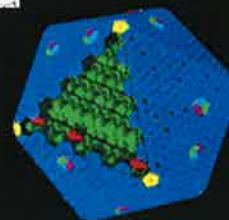

# Factory Assembly

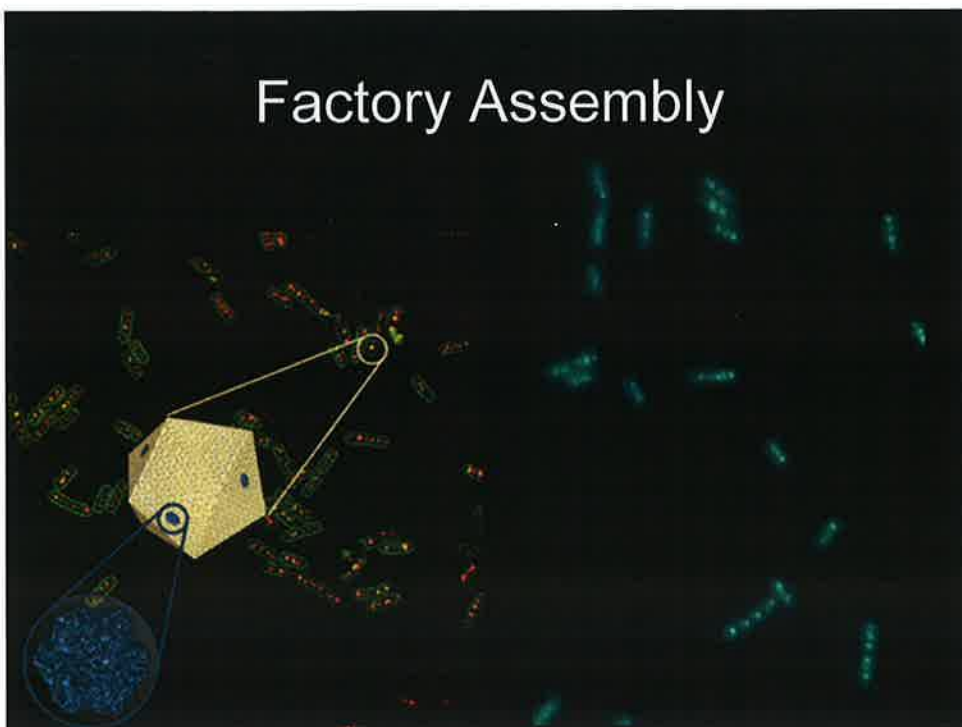

# Factory Assembly

00:00 12

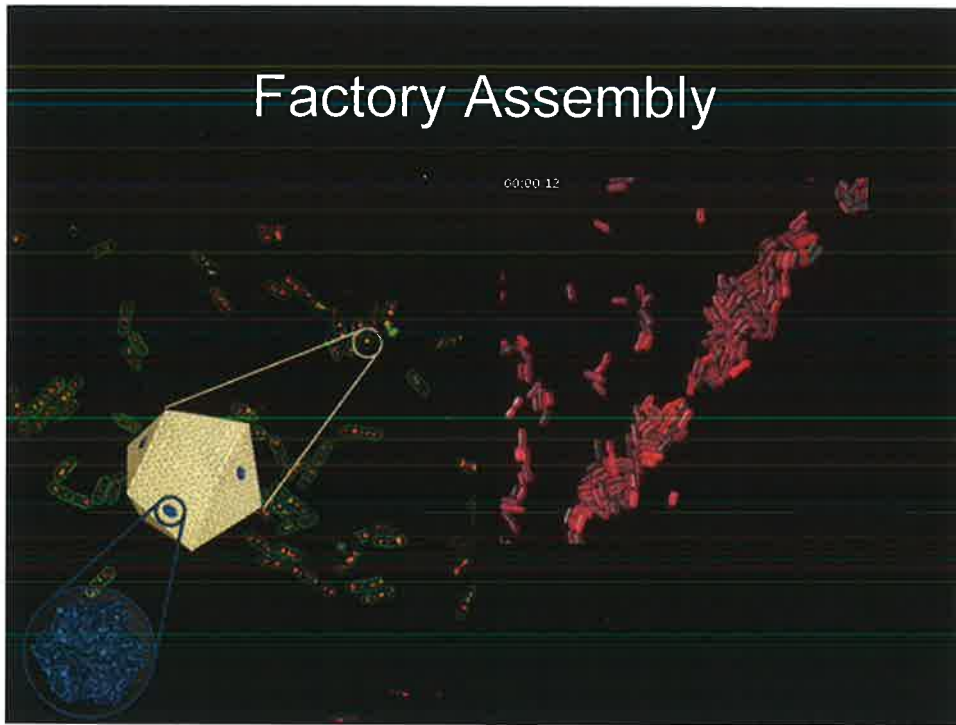

# Design, Test and Install



Improving photosynthesis  
Plant Production of High-Value Products

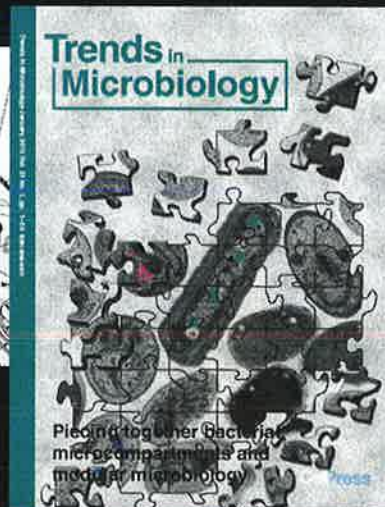

Microbial Cell Factories



# Acknowledgements

- Colleagues in the MSU-DOE Plant Research Laboratory, Department of Biochemistry and Molecular Biology and AgBioResearch
- Hannah Endowment



MICHIGAN STATE  
UNIVERSITY

## ATTACHMENT A

**29.00 SMOKING, USE AND SALE OF TOBACCO PRODUCTS**

29.01 \* Use of Tobacco Products and Smoking Prohibited

29.02 \* Sale of Tobacco Products Prohibited

29.03 Definitions

29.04 Exceptions

.01 \* No person shall (a) smoke, or (b) otherwise use any product derived from or containing tobacco, on any property governed by the Board.

.02 \* Products derived from or containing tobacco may not be sold on any property governed by the Board.

.03 For the purpose of this Ordinance:

To “smoke” means inhaling, exhaling, burning, or carrying any lighted or heated tobacco or plant product intended for inhalation, whether natural or synthetic. To “smoke” also includes the use with any such tobacco or plant product of a pipe or hookah; of any electronic smoking device which creates, in any manner, an aerosol or vapor, in any form; or of any other oral smoking device.

“Products derived from or containing tobacco” include, without being limited to, cigarettes (including clove, bidis, kreteks), electronic cigarettes, aerosol or vapor nicotine delivery devices, cigars and cigarillos, pipe tobacco, hookah-smoked products, and oral tobacco (spit and spitless, smokeless, chew, snuff).

.04 Notwithstanding the foregoing, all FDA-approved nicotine replacement therapy products are permitted when used for purposes of cessation. Other exceptions to this Ordinance may be authorized by the Secretary of the Board pursuant to guidelines issued by the Secretary of the Board.

Enacted: September 15, 1964

Amended: May 16, 1969

Amended: December 10, 1994

Amended: October 13, 1995

Amended: August 1, 2016

\* Denotes Civil Infraction

**EXHIBIT A**

**35.50\* Taxicab regulation; license or permit required**

**.50\*** Taxicab Regulation: The Police Chief and Director of Public Safety is hereby authorized to prohibit the operation of any taxicab or other vehicle for hire on campus which does not bear a current and valid license or permit issued by a duly authorized state or local regulatory body. For purposes of this section, vehicles for hire shall include personal vehicles operated through ride-sharing networks. Taxicab drivers and drivers for hire shall be required to present proof of compliance to police officers upon request. The Department of Police and Public Safety shall maintain and make available to the campus community a current list of local authorized taxicab companies and drivers for hire.

### OPTION EXTENSION AGREEMENT TERM SHEET

**Party:** Bioplastic Polymers and Composites, LLC

**Option:** Option on Patent Rights

**Term:** Extending term of previous Option Agreement to June 30, 2016, further extendable upon mutual agreement

**Technology:** MSU Invention Disclosure No. TEC2044-0132 "Bulk Reactive Extrusion Polymerization of 1,4-Dioxin-2-One Producing Thermal Stabilized 1,4-Dioxin-2-One (Co)polymers"

MSU Invention Disclosure No. TEC2006-0079 "Novel Tryglycerides and Method of Preparation Thereof"

MSU Invention Disclosure No. TEC2009-0007 "Moisture Curable Natural Oil and Fat Composition and Preparation Thereof"

MSU Invention Disclosure No. TEC2015-0081 "Polyols from Biomass and Polymeric Products Produced Therefrom"

MSU Invention Disclosure No. TEC2015-0127 "Interpenetrating Polymer Networks Derived from Silylate Tryglyceride Oils and Polysiloxanes"

U.S. Patent Nos. 7,361,727; 8,110,036; 8,217,193; 8,349,032; and 9,000,103; and U.S. Patent Application No. 14/034,611 with international counterparts

The parties may add or remove technologies under the agreement, including improvements generated under a separate sponsored research agreement, provided that the change does not affect the financial consideration of the parties or the nature or extent of any pecuniary interest of MSU personnel.

**Technology's Potential**

**Commercial Utilization:** Environmentally friendly printers

**Payment Terms:** \$5,000 option fee payable within 30 days of effective date

**Services Provided:** By MSU Bioplastic Polymers and Composites, LLC:  
None contemplated under agreement

By Bioplastic Polymers and Composites, LLC to MSU: None contemplated under agreement

**Use of University**

**Facilities/Personnel:** None

**Organization Type:** Michigan limited liability company

**Personnel Interest:** Dr. Ramani Narayan, a Professor in the Department of Chemical Engineering, and members of his family own or have options to buy an equity interest of more than 1% of the company. Dr. Narayan is also an officer of Bioplastic Polymers and Composites, LLC.

## LEASE TERM SHEET

<b>Party:</b>	BoroPharm, Inc.
<b>Agreement:</b>	Lease for 5,424 square feet of assignable laboratory suite space in Rooms 239 and 246 of the 200-wing of MSU Bioeconomy Institute in Holland, MI
<b>Term:</b>	Six months, with company option to extend for an additional twenty-four months
<b>Contractual Terms:</b>	\$10,170 monthly, triple net rent. Free parking for BoroPharm, Inc. employees on the Institute's surface lot. Use of incidental office services (e.g., photocopying) at the Institute's then-current standard rate sheet during the lease term.
<b>Services Provided:</b>	By MSU to BoroPharm, Inc.: incidental services by mutual agreement, as provided in the contract terms  By BoroPharm, Inc. to MSU: None contemplated under agreement
<b>Use of University Facilities/Personnel:</b>	Incidental use of MSU services/personnel by BoroPharm, Inc. at rates set forth in the contractual terms
<b>Organization Type:</b>	Delaware corporation headquartered in Novi, Michigan with R&D facilities in Ann Arbor, Michigan
<b>Personnel Interest:</b>	Dr. Robert E. Maleczka, Professor and Chairperson in the Department of Chemistry, and Dr. Milton R. Smith, Professor in the Department of Chemistry, and members of their families own or have options to buy an ownership interest of more than 1% of the company.

## REVISED LICENSE AGREEMENT TERM SHEET

<b>Party:</b>	HAO Tech, LLC
<b>License:</b>	Exclusive license on copyright to computer code in the field of sleep monitoring and breathing monitoring
<b>Term:</b>	Ten years from the effective date of the agreement
<b>Technology:</b>	MSU Invention Disclosure No. TEC2014-0044 "iSleep: Unobtrusive Sleep Monitoring System Using Smartphones"  MSU Invention Disclosure No. TEC2014-0015 "Monitoring and Optimizing Breath and Footsteps During Exercise Using Smartphones"  The parties may add or remove technologies under the agreement, including improvements generated under a separate sponsored research agreement, provided that the change does not affect the financial consideration of the parties or the nature or extent of any pecuniary interest of MSU personnel.
<b>Technology's Potential Commercial Utilization:</b>	Sleep monitoring for individual well-being or activity tracking
<b>Payment Terms:</b>	Equity position of 5% in HAO Tech, LLC. Payment of a running royalty of 8% on net sales and related advertising income; 50% on all sublicensing revenues.
<b>Services Provided:</b>	By MSU to HAO Tech, LLC: None contemplated under agreement  By HAO Tech, LLC to MSU: None contemplated under agreement
<b>Use of University Facilities/Personnel:</b>	None
<b>Organization Type:</b>	Michigan limited liability company
<b>Personnel Interest:</b>	Dr. Gouliang Xing, an Associate Professor in the Department of Computer Science and Engineering, and members of his family own or have options to buy an ownership interest of more than 1% of the

company. Dr. Xing is also a member of HAO Tech, LLC.



### SPONSORED RESEARCH AGREEMENT TERM SHEET

**Party:** Metna Corporation

**Contracts:** Subcontract under U.S. Army Corps of Engineers W9132T-15-C-002: Sponsored research agreement subcontract: "STTR Ultra-High Performance Concrete"

**Term:** July 1, 2015 to June 30, 2016

**Payment Terms:** \$37,000 to MSU for testing and evaluation services

**Services Provided:** By MSU to Metna: testing and evaluation of various concrete formulations  
By Metna to MSU: none contemplated under agreement

**Use of University Facilities/Personnel:** Dr. Ventkatesh Kodur, a Professor in the Department of Civil and Environmental Engineering will engage in research and provide the services described above.

**Organization Type:** Delaware corporation based in Lansing, Michigan

**Personnel Interest:** Dr. Parviz Soroushian, a Professor in the Department of Civil and Environmental Engineering, and members of his family own or have options to buy an ownership interest of more than 1% of the company. Dr. Soroushian is also the President of Metna Corporation.

## SPONSORED RESEARCH AGREEMENT TERM SHEET

<b>Party:</b>	QuantumBio, Inc.
<b>Sponsored Research Agreement:</b>	Subcontract under National Institutes of Health ("NIH") grant number 1R44GM112406-01, entitled "Development and Deployment of the Movable Type Method for Drug Discovery and Design"
<b>Term:</b>	September 10, 2014 to March 9, 2015*
<b>Technology's Potential Commercial Utilization:</b>	Pharmaceutical companies employ this type of methodology in their quest for new drugs.
<b>Payment Terms:</b>	\$49,500 to MSU to fund the research
<b>Services Provided:</b>	<p>By MSU to QuantumBio, Inc.: Validate the performance of MSU's Movable Type (MT) algorithm to predict the free energy of binding a drug molecule to a receptor and also to predict how a drug molecule binds into the pocket of a protein receptor. This <i>in silico</i> validation of MT will enhance the scientific and commercial viability of this methodology for use to discover new drugs in the pharmaceutical industry.</p> <p>By QuantumBio, Inc. to MSU: None contemplated under agreement</p>
<b>Use of University Facilities/Personnel:</b>	Institute for Cyber Enabled Research/Dr. Kenneth M. Merz
<b>Organization Type:</b>	Delaware corporation
<b>Personnel Interest:</b>	Dr. Kenneth M. Merz, Jr., a Professor in the Departments of Chemistry and Biochemistry & Molecular Biology, and members of his family own or have options to buy an ownership interest of more than 1% of the company. Dr. Merz is also an officer of the company.

\*QuantumBio was awarded this NIH grant after Dr. Merz came to MSU from the University of Florida. The work under this contract is complete. QuantumBio is ready to transfer the funds if the MSU Board approves this agreement. The

delay in seeking approval for this agreement results from miscommunications between QuantumBio and MSU's Office of Sponsored Programs.

## SPONSORED RESEARCH AND DEPLOYMENT AGREEMENT TERM SHEET

<b>Party:</b>	QuantumBio, Inc.
<b>Research Agreement:</b>	Subcontract under National Institutes of Health ("NIH") grant number 4R44GM099411-02, entitled "Research and Deployment of a Quantum Mechanical NMR Tool for Fragment Based Drug Discovery – Phase II"*
<b>Term:</b>	March 10, 2015 through May 31, 2016*
<b>Technology's Potential Commercial Utilization:</b>	Pharmaceutical companies employ this type of design methodology in their quest for new drugs.
<b>Payment Terms:</b>	\$50,000 to MSU to fund research (the remainder of the funds granted to Dr. Merz under the grant prior to his joining MSU from the University of Florida)
<b>Services Provided:</b>	<p>By MSU to QuantumBio, Inc.: Validate the performance of MSU's Automatic Fragmentation Quantum Mechanical/Molecular Mechanical ("AF-QM/MM") NMR chemical shift prediction tool to predict the structure of a drug molecule bound to a receptor. This validation will enhance the scientific and commercial viability of this <i>in silico</i> computational tool to accelerate the discovery of novel drug molecules in the pharmaceutical industry.</p> <p>By QuantumBio, Inc. to MSU: None contemplated under agreement</p>
<b>Use of University Facilities/Personnel:</b>	Institute for Cyber Enabled Research/Dr. Kenneth M. Merz
<b>Organization Type:</b>	Delaware corporation
<b>Personnel Interest:</b>	Dr. Kenneth M. Merz, Jr., a Professor in the Departments of Chemistry and Biochemistry & Molecular Biology, and his family own or have options to buy an ownership interest of more than 1% of the company. Dr. Merz is also an officer of the company.

\*QuantumBio was awarded this NIH grant while Dr. Merz was employed at the University of Florida. MSU recruited Dr. Merz after his work on the grant began. Only recently has QuantumBio approved the sub-award for the work to be continued at MSU. The Office of Sponsored Programs did not learn of this phase of the research from the faculty member until late April 2015. MSU's fulfillment of this phase of the research is complete in advance of the expiration of the term and transfer of funds will be made upon execution of the contract.

## SPONSORED RESEARCH DEVELOPMENT AND DEPLOYMENT AGREEMENT TERM SHEET

<b>Party:</b>	QuantumBio, Inc.
<b>Research Agreement:</b>	Subcontract under National Institutes of Health ("NIH") grant number 4R44GM099411-02, entitled "Development and Deployment of the Movable Type Method for Drug Discovery and Design – Phase II"*
<b>Term:</b>	March 10, 2015 through February 28, 2017*
<b>Technology's Potential Commercial Utilization:</b>	Pharmaceutical companies employ this type of design methodology in their quest for new drugs.
<b>Payment Terms:</b>	\$196,838 to MSU to fund research
<b>Services Provided:</b>	<p>By MSU to QuantumBio, Inc.: Further validate the performance of the Movable Type (MT) algorithm* to predict the free energy of binding a drug molecule to a receptor and also to predict how a drug molecule binds into the pocket of a protein receptor. This will be accomplished by the examination of both freely available validation test sets of drug/protein complexes, but will also be tested via collaborations with select pharmaceutical companies on their internal data sets. This further <i>in silico</i> validation of MT will enhance the scientific and commercial viability of this methodology for use to discover new drugs in the pharmaceutical industry.</p> <p>By QuantumBio, Inc. to MSU: None contemplated under agreement</p>
<b>Use of University Facilities/Personnel:</b>	Institute for Cyber Enabled Research/Dr. Kenneth M. Merz
<b>Organization Type:</b>	Delaware corporation
<b>Personnel Interest:</b>	Dr. Kenneth M. Merz, Jr., a Professor in the Departments of Chemistry and Biochemistry & Molecular Biology, and members of his family own or have options to buy an ownership interest of more than 1% of the company. Dr. Merz is also an officer of the company.

\*QuantumBio was awarded this NIH grant after Dr. Merz came to MSU from the University of Florida. The Moveable Type Method was originally developed at, and a patent application for it filed by, the University of Florida. Both inventors have since joined the faculty at MSU. Under the terms of an Inter-institutional Agreement, the patent rights are now co-owned by the University of Florida and MSU. The research is ongoing; work under this contract has already started. The Office of Sponsored Programs did not learn of this phase of the research from the faculty member until late April 2015. QuantumBio is ready to transfer funding for this phase of the research upon execution of the contract.

**PURCHASE AGREEMENT TERM SHEET**

**Party:** Supremo\*

**Agreement:** Purchase Agreement for a Josef EGS-1 English Horn, case, swab, and two bocals

**Payment Terms:** \$8,800\*

**Services Provided:** By MSU to Supremo: None contemplated under agreement  
By Supremo to MSU: None contemplated under agreement

**Use of University Facilities/Personnel:** None

**Organization Type:** Michigan sole proprietorship

**Personnel Interest:** Dr. Jan Eberle, a Professor in the College of Music, owns Supremo.

\*Supremo is the only authorized US supplier of the Josef EGS-1 Horn. The only other supplier is in Germany. Supremo is offering to sell the horn to MSU at a discount of 20% off the list price of \$10,980.